

**Test Square**

**2" x 2"**

**5cm x 5cm**

$\frac{1}{2}$

1a

1b

1b

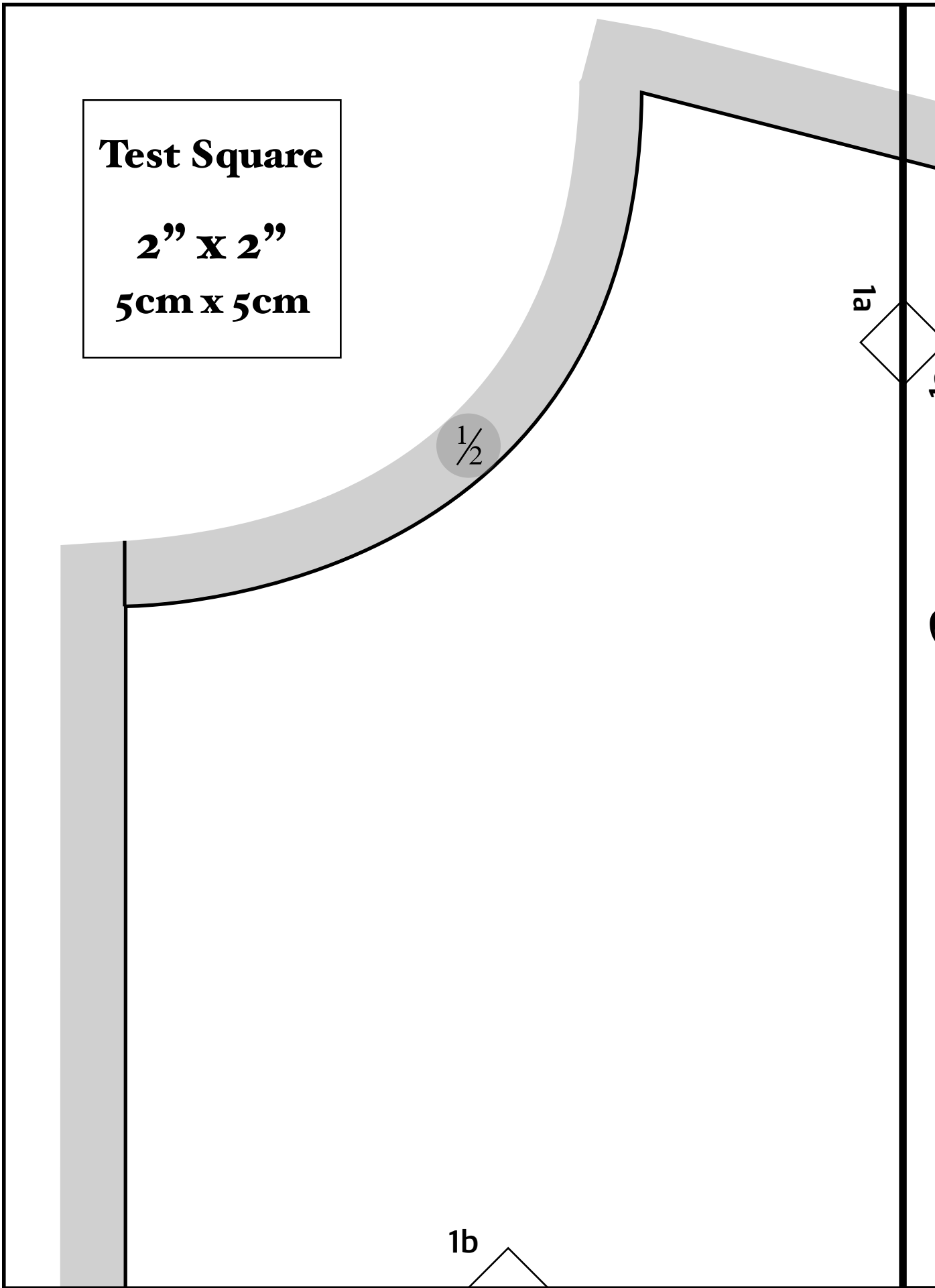



1a

$\frac{1}{2}$

*Sachi's Studio*  
**Base Patten**

**Front**

2a

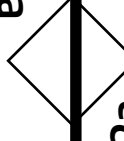

2b

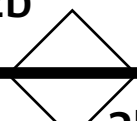

2c

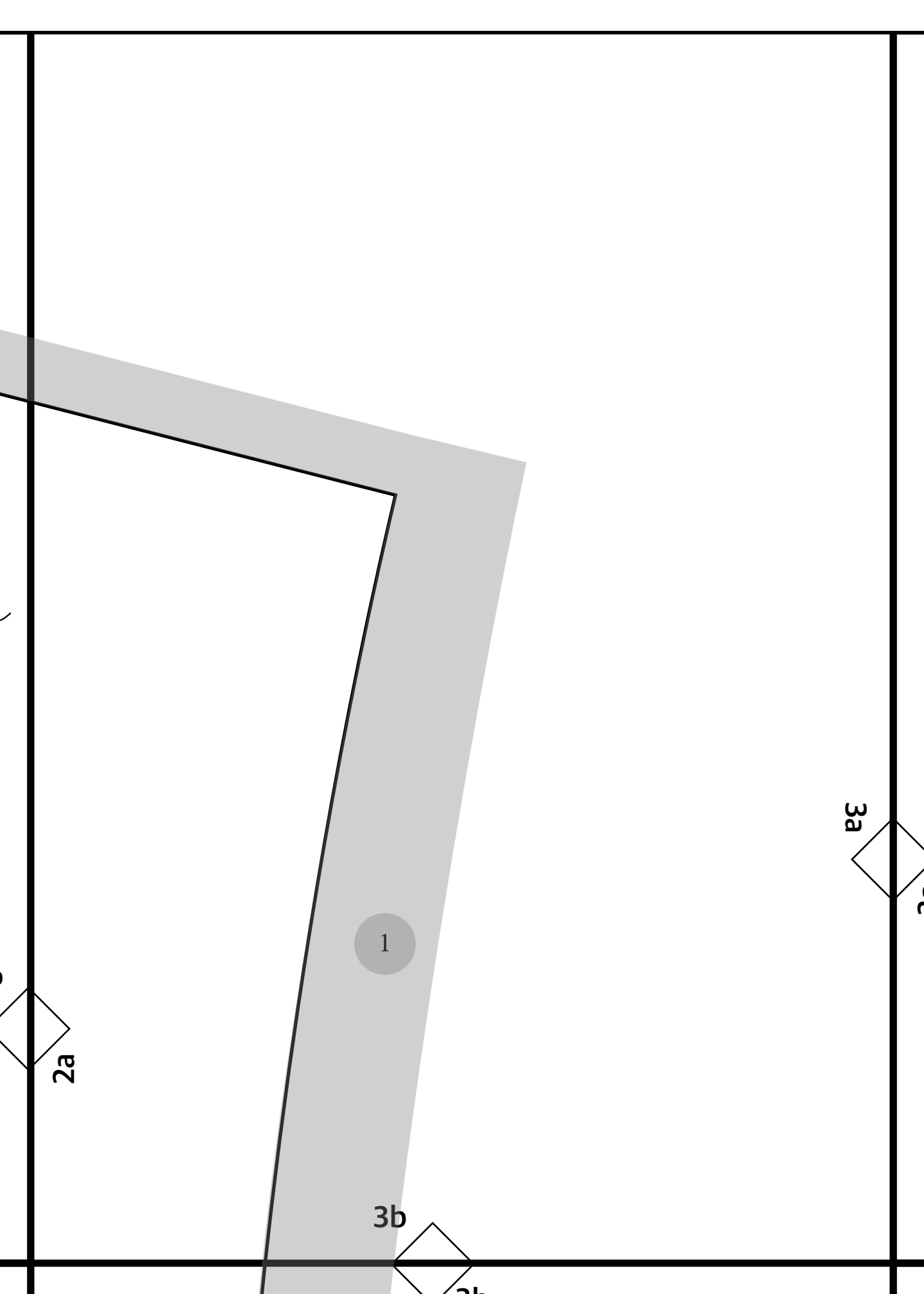

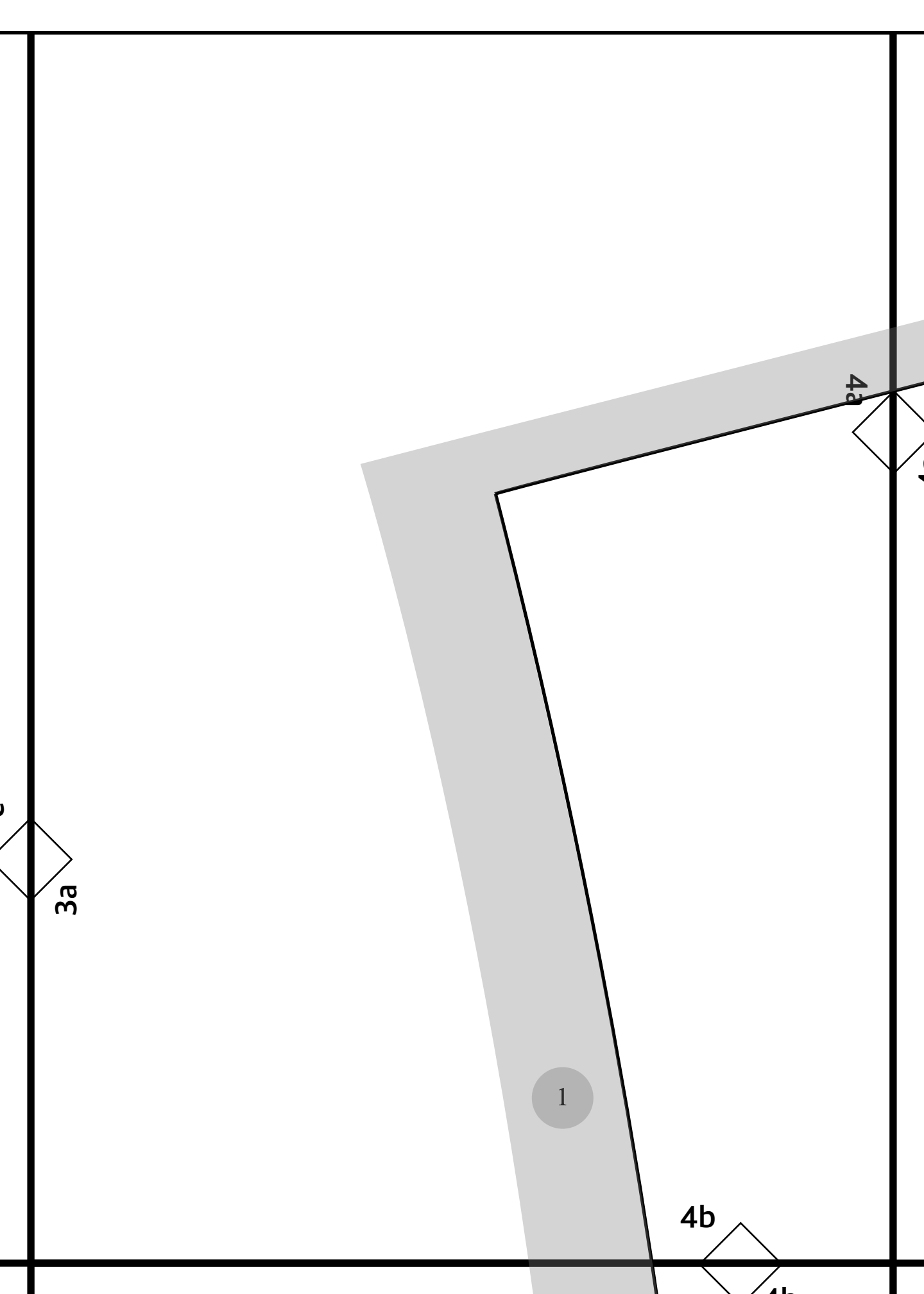

1

3a

4a

4b

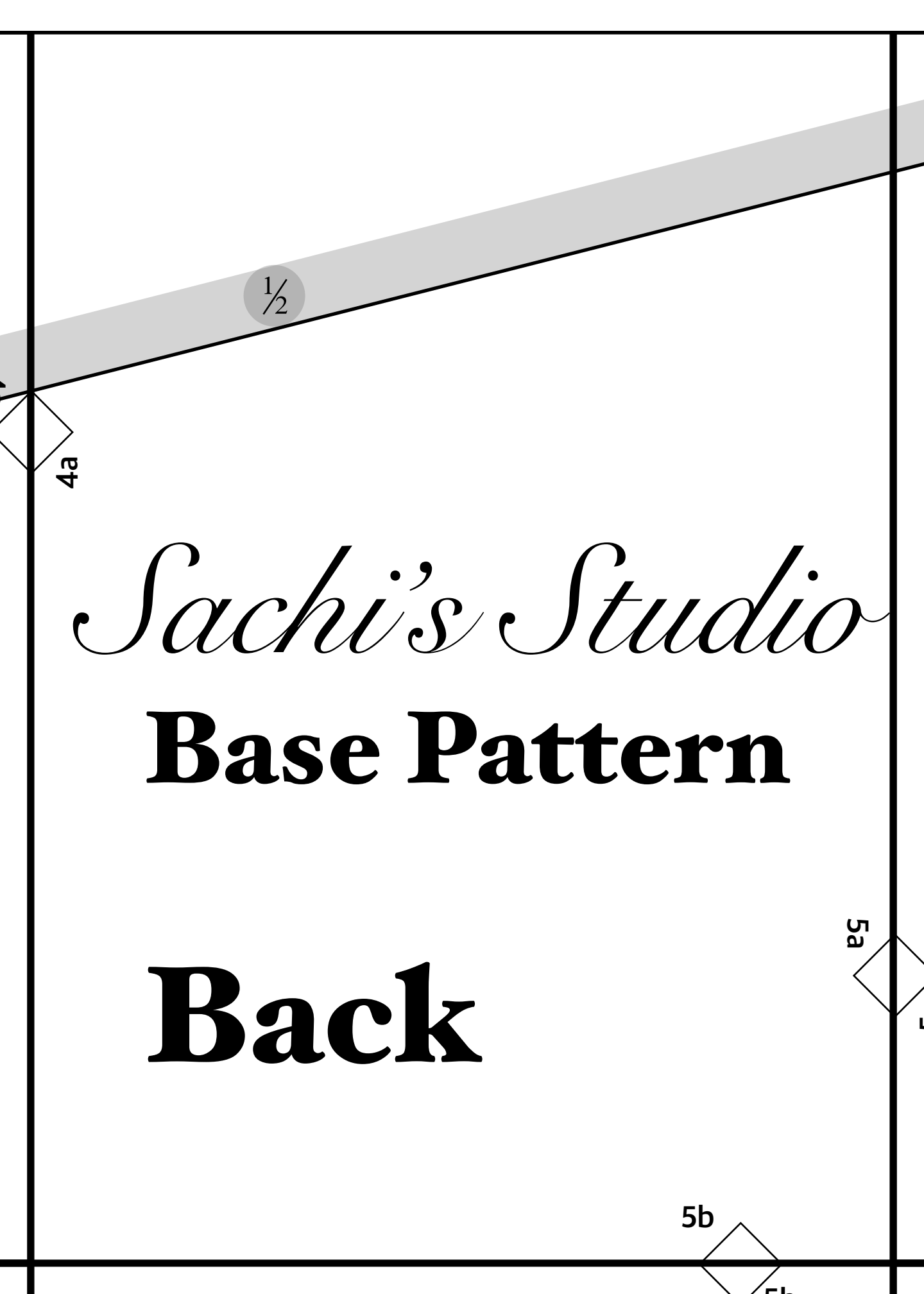

$\frac{1}{2}$

4a

*Sachi's Studio*  
**Base Pattern**

**Back**

5a

5b

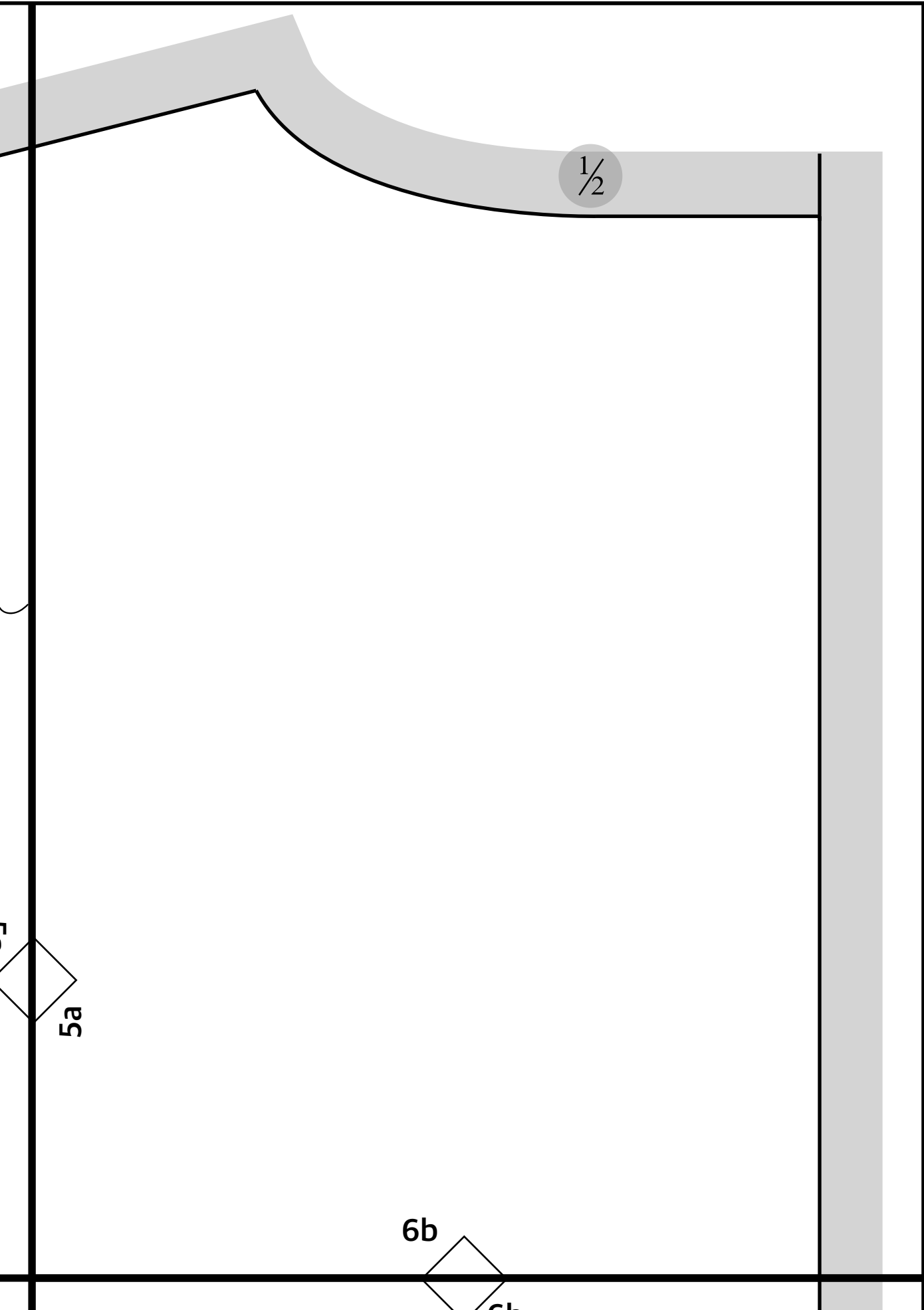



1b

1c

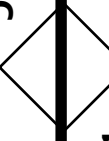

1/2

# Hem line A

1d

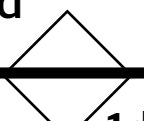

1e

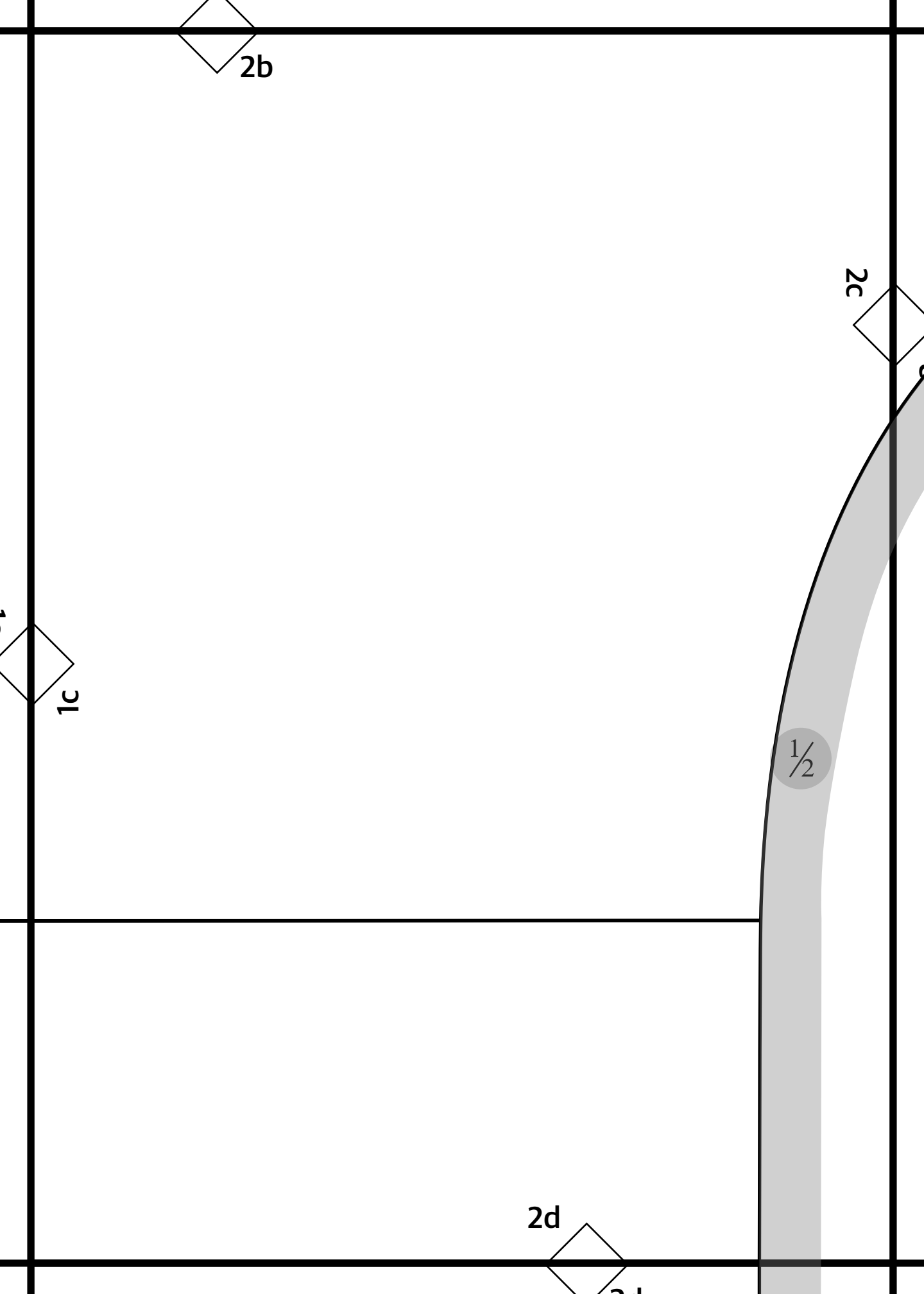

1a

1c

2b

2c

2d

$\frac{1}{2}$



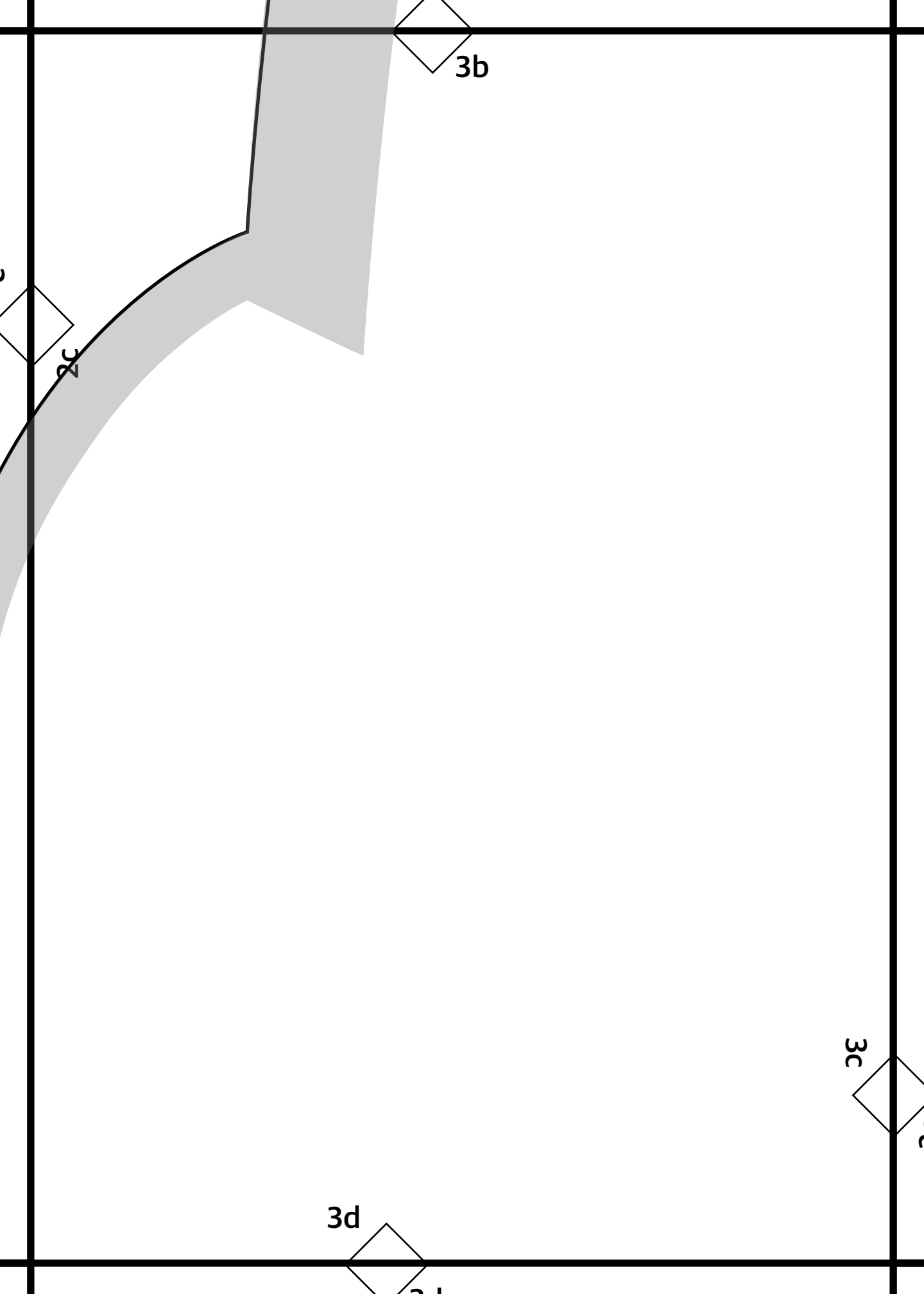

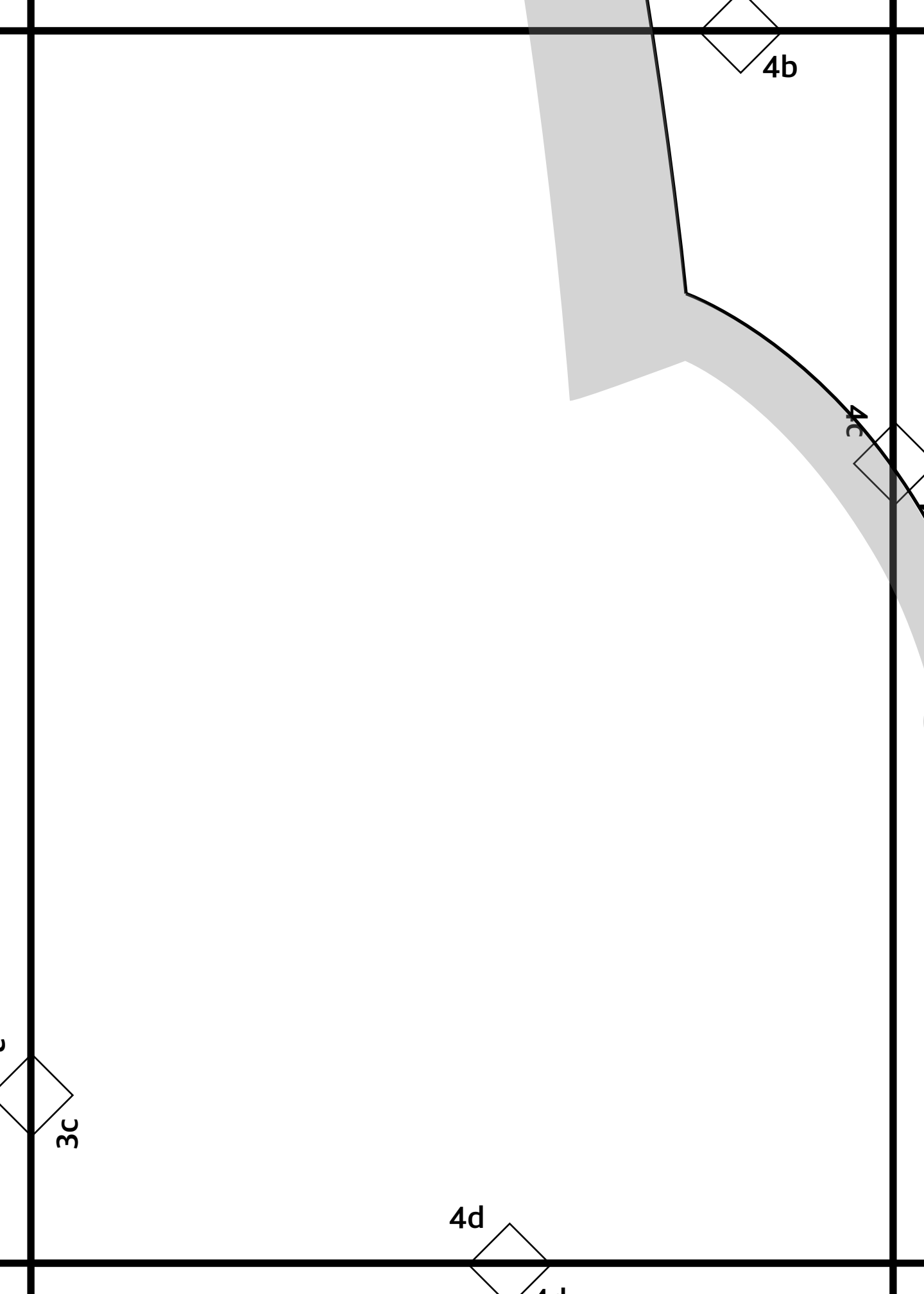

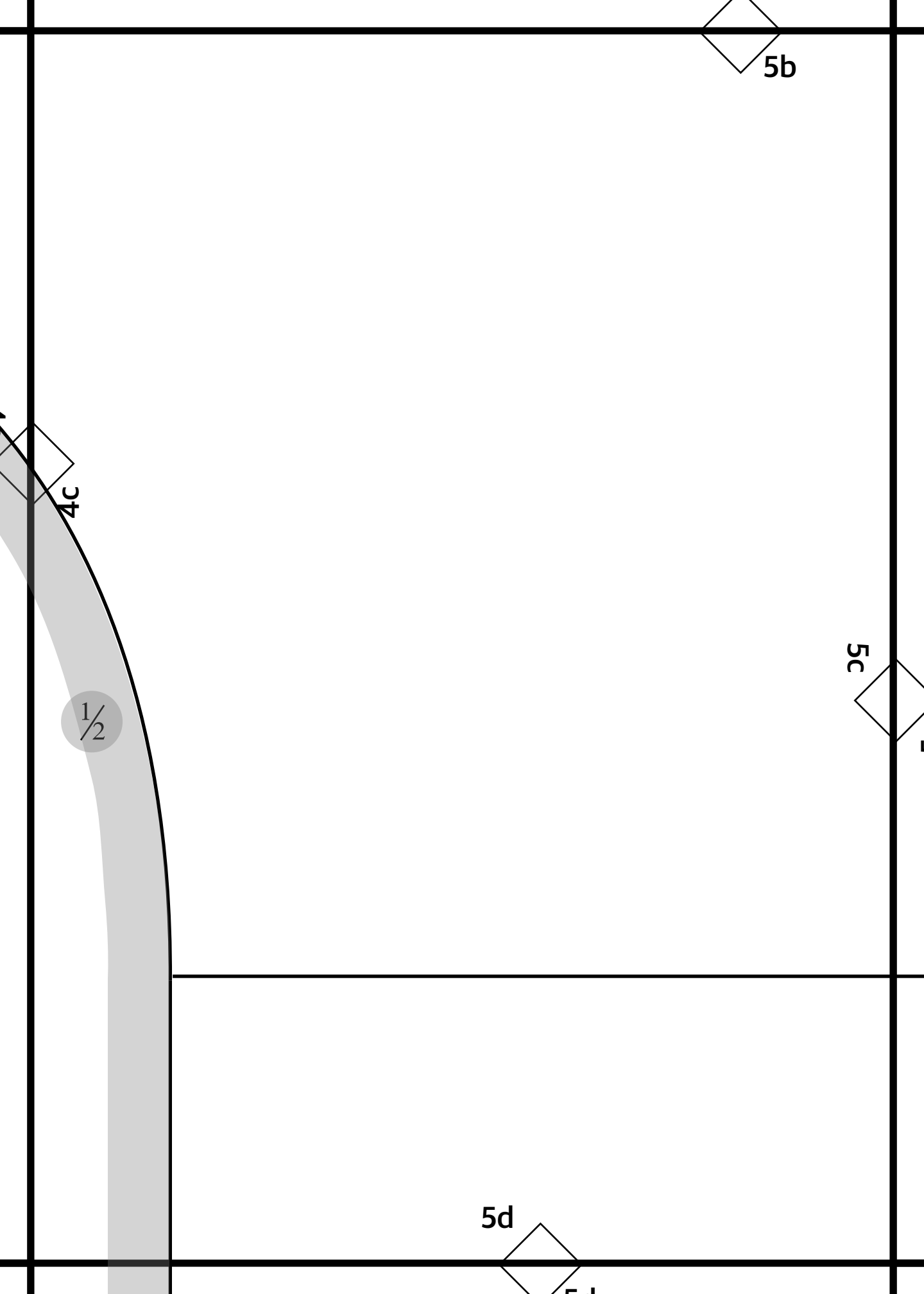

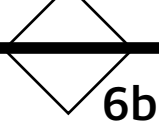

6b

$\frac{1}{2}$

7



5c

# Hem line A

6d



6d



1d

**Hem line B**

**Hem line C**

**Hem line D**



1e

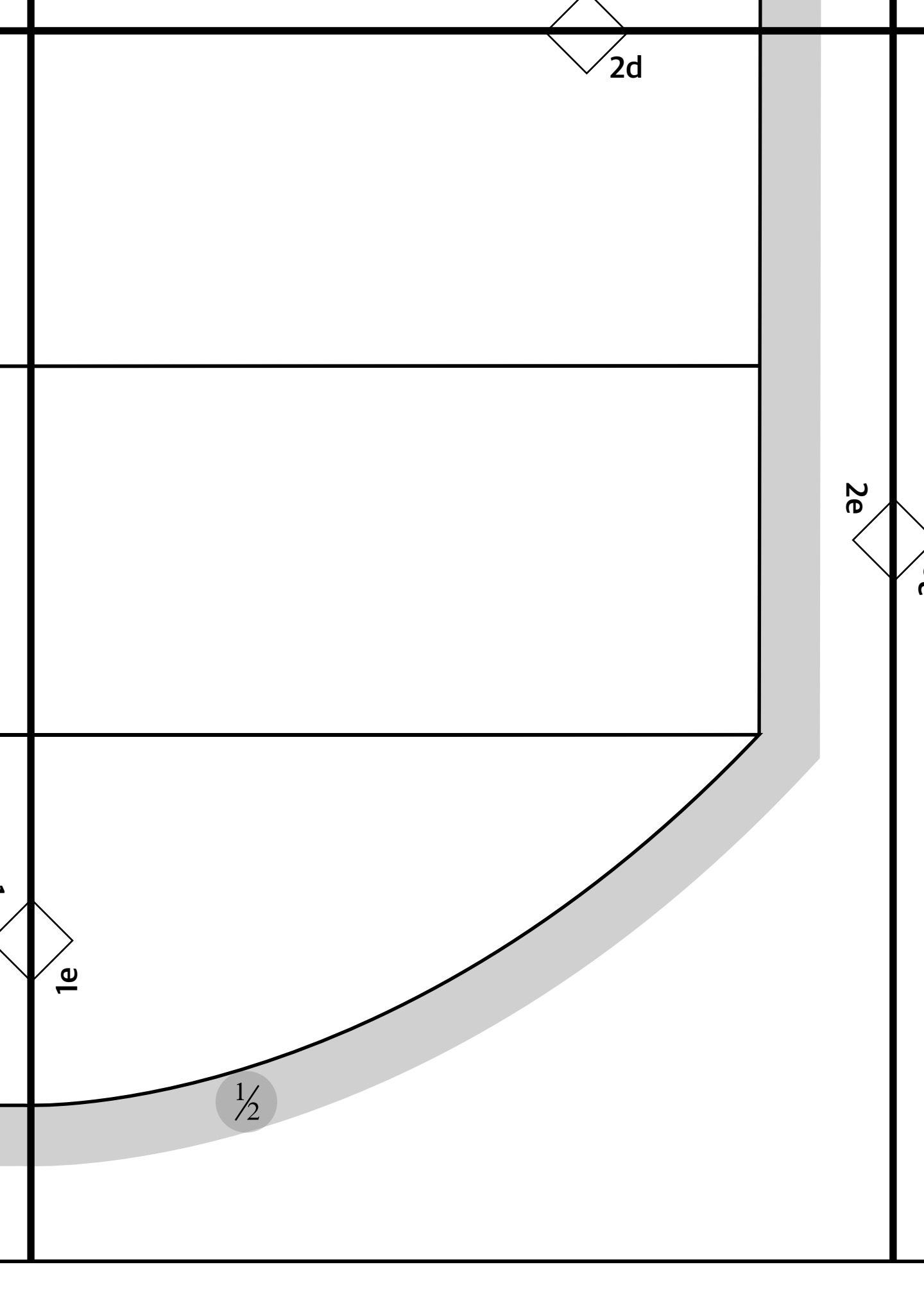

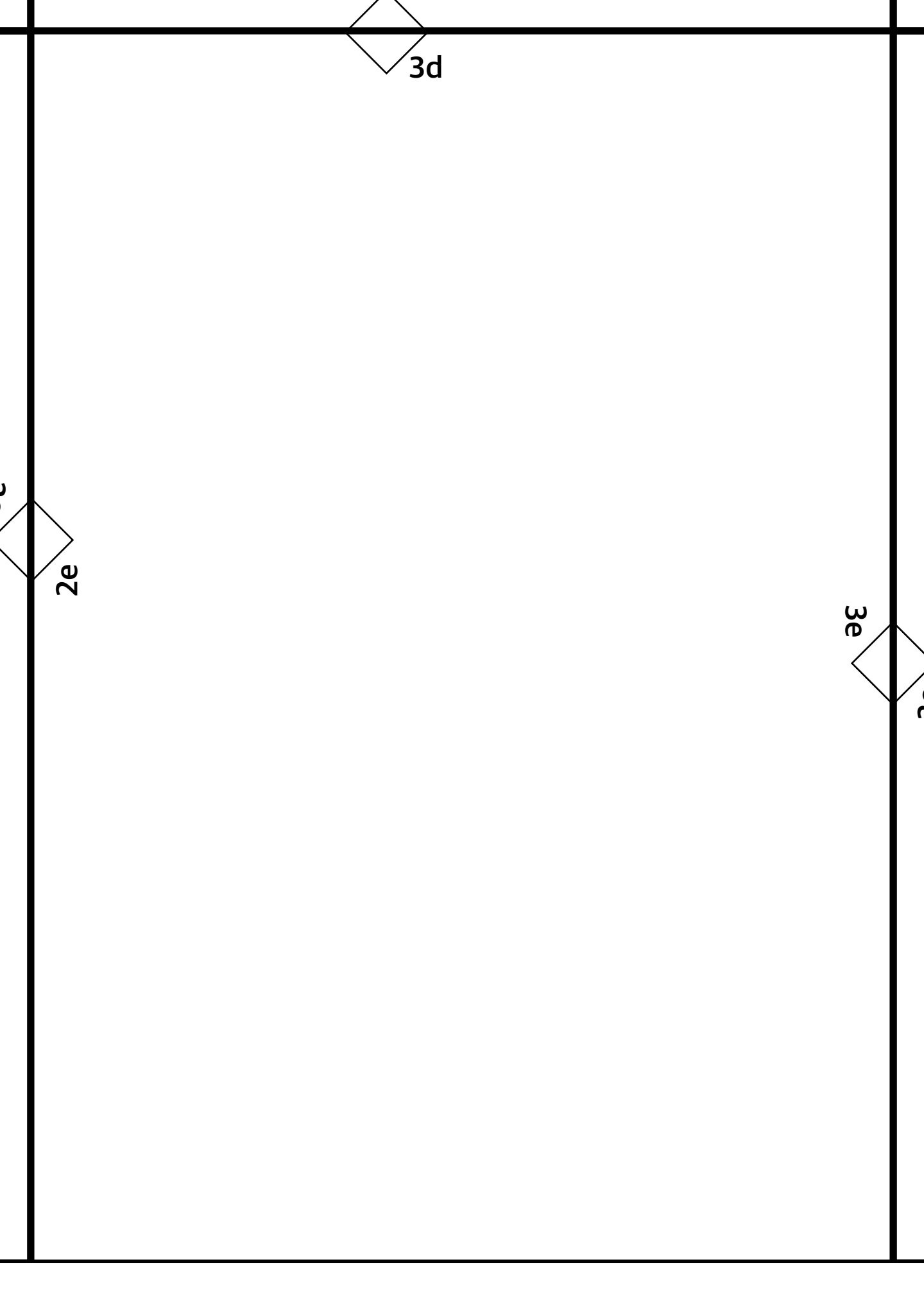

4d

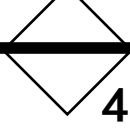

3e

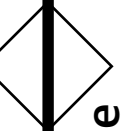

4e





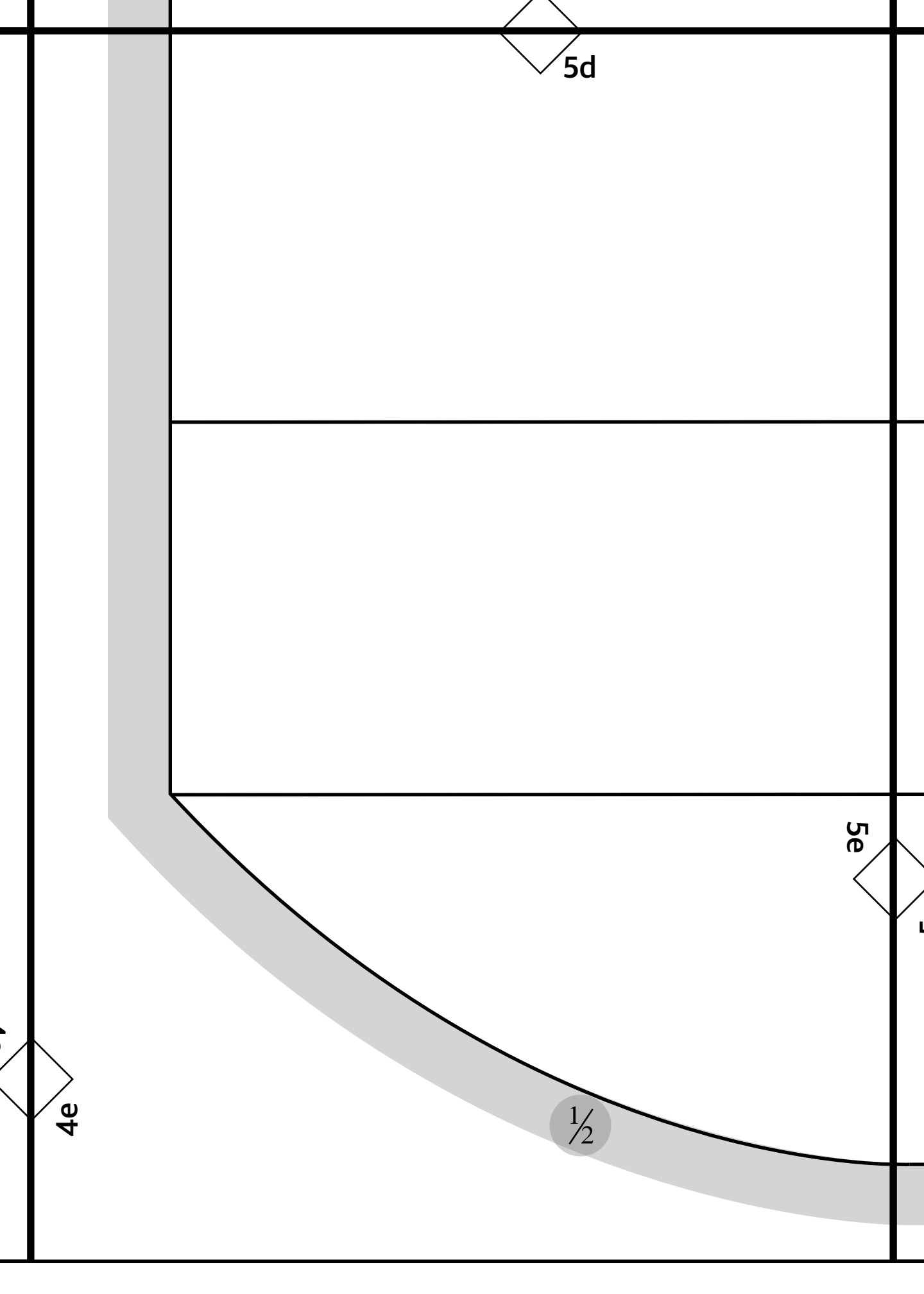

5d

5e

4e

1/2

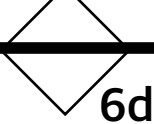

6d

**Hem line B**

**Hem line C**

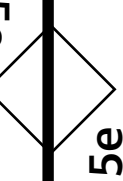

5e

**Hem line D**